

KARTA PRACY - NUMER 1

POTRZEBNE MATERIAŁY:



CZY JEMY
KWIATY?



DOPASUJ ZWIERZĘTA DO ICH ŚLADÓW.

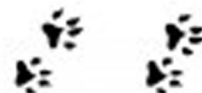

TAK ! BROKUŁY
I KALAFIOR
TO PĄKI KWIATÓW.



TERAPIA RĘKI - POMYSŁY
AGNIESZKA WOJCIECHOWSKA

KARTA PRACY - NUMER 2

POTRZEBNE MATERIAŁY:



POLICZ ZWIERZĘTA I WPISZ ODPOWIEDNIĄ LICZBĘ.

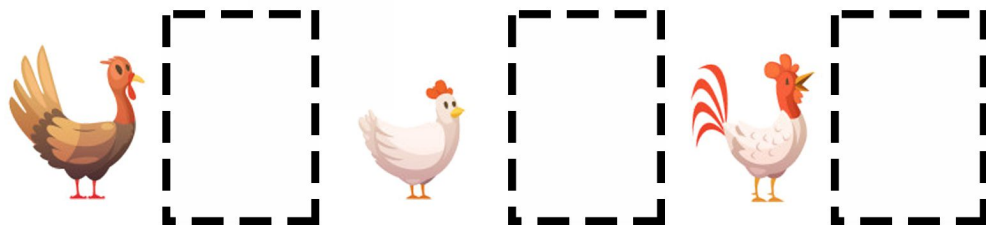
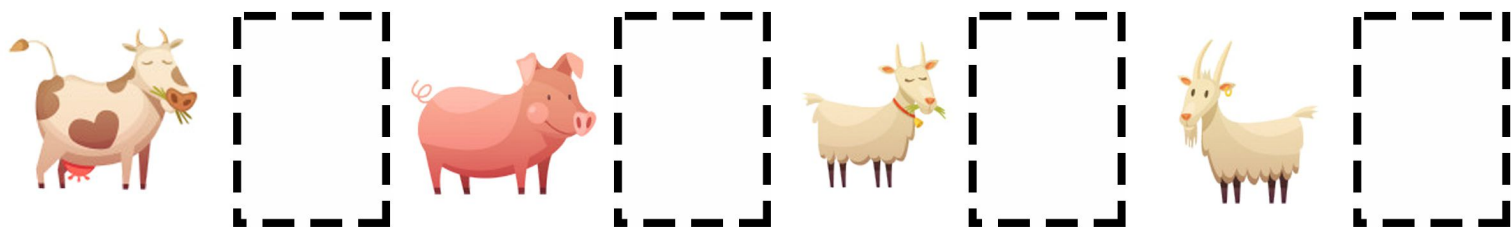
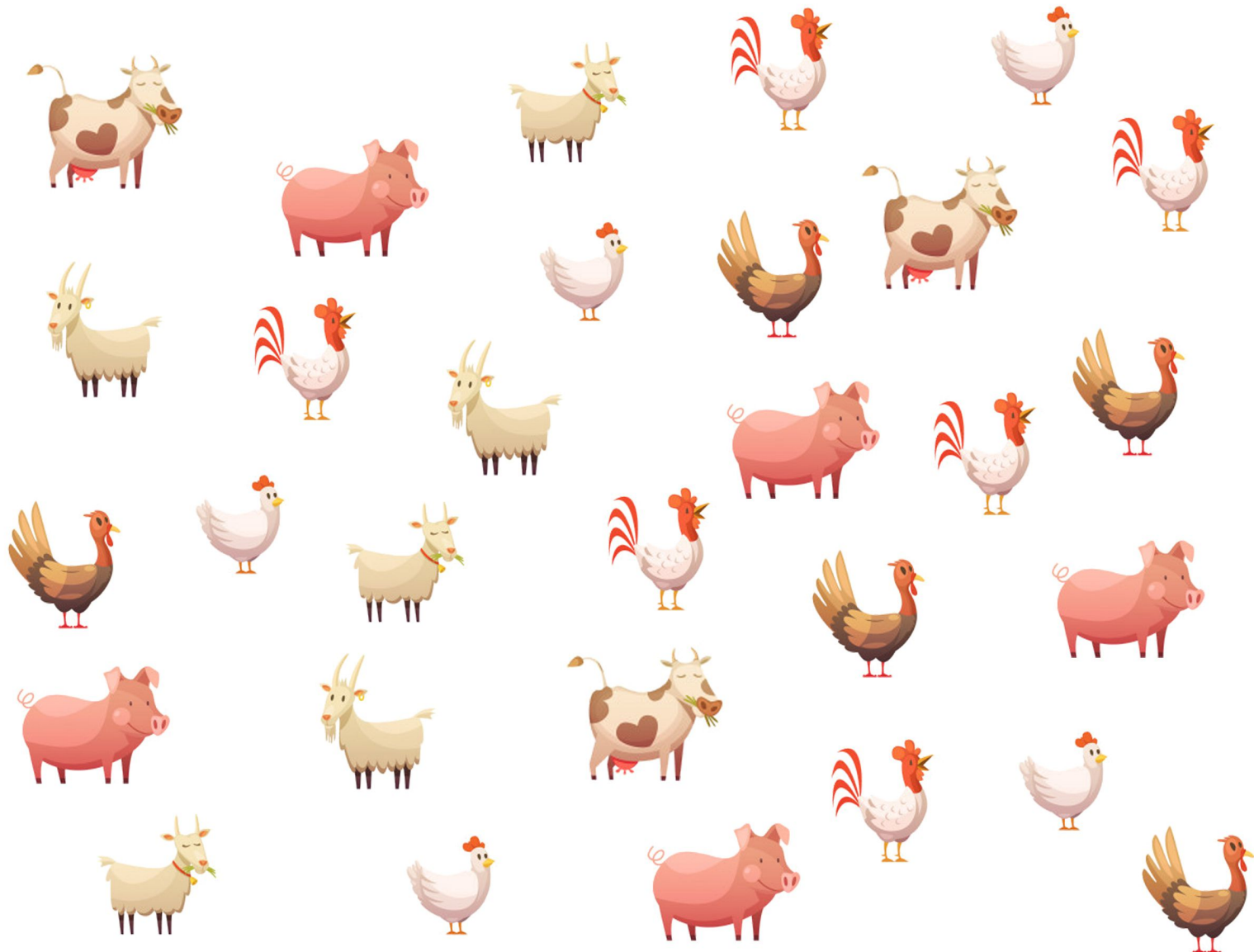

KARTA PRACY - NUMER 3

POTRZEBNE MATERIAŁY:



CO TU NIE PASUJE?

CZY JEMY
KORZENIE?

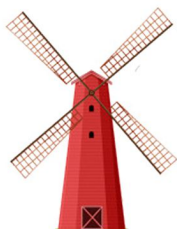
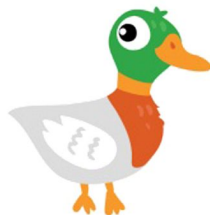
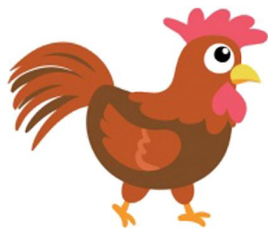

MARCHEWKA,
BURAKI, RZODKIEWKA
TO KORZENIE.

TERAPIA RĘKI - POMYSŁY
AGNIESZKA WOJCIECHOWSKA



KARTA PRACY - NUMER 4

POTRZEBNE MATERIAŁY:



ILE JAJEK ROCZNIE
ZNOSI KURA?



POŁĄCZ ZWIERZĘTA Z PRZEDMIOTAMI.

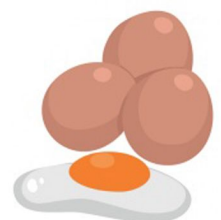

OKOŁO 140.



KARTA PRACY - NUMER 5

POTRZEBNE MATERIAŁY:



NARYSUJ ODPOWIEDNIĄ ILOŚĆ WARZYW
W GRZĄDCE.



3



4



5



6

KARTA PRACY - NUMER 6

POTRZEBNE MATERIAŁY:



DORYSUJ DRUGĄ POŁOWĘ OBRAZKA.

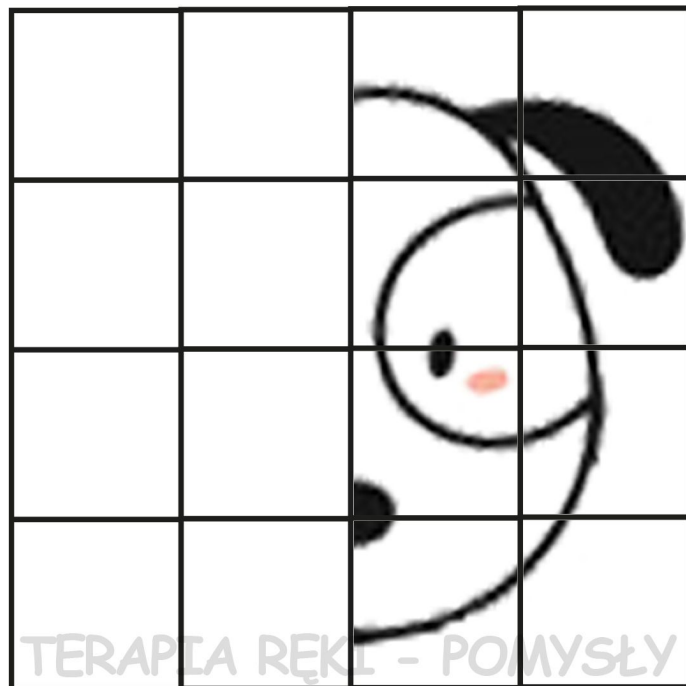
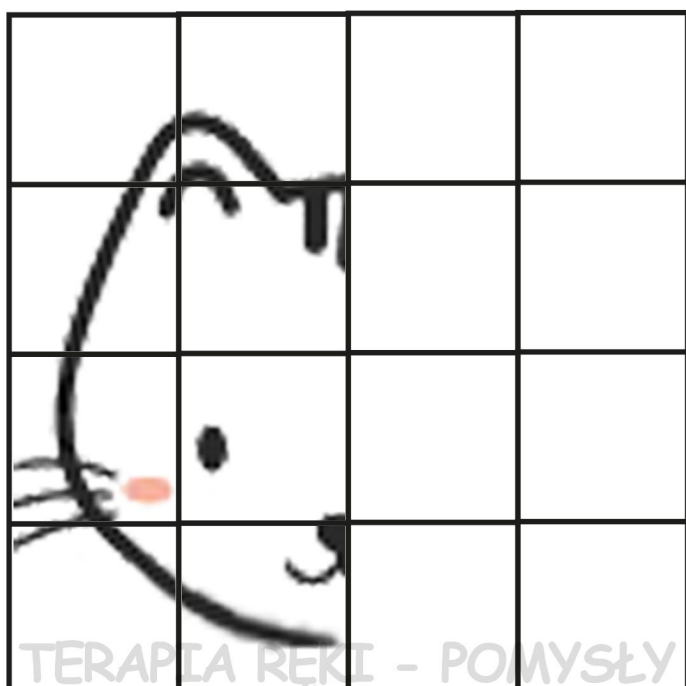
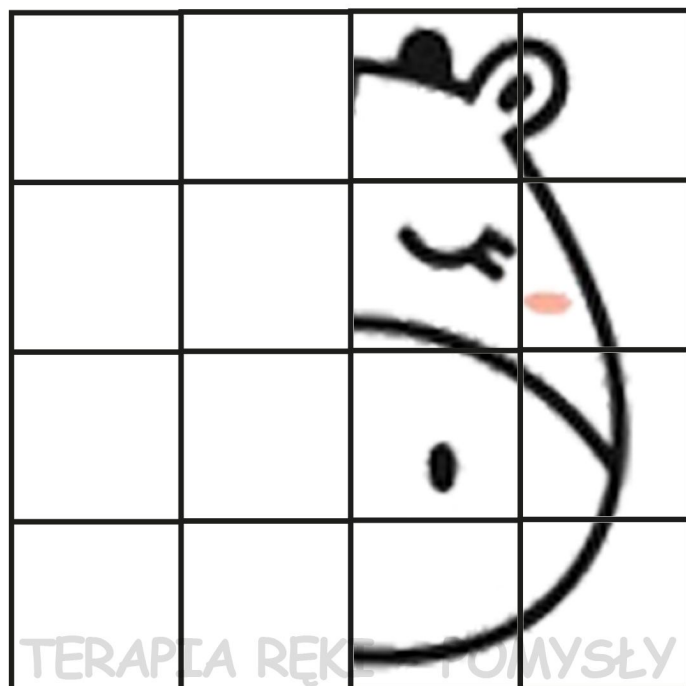
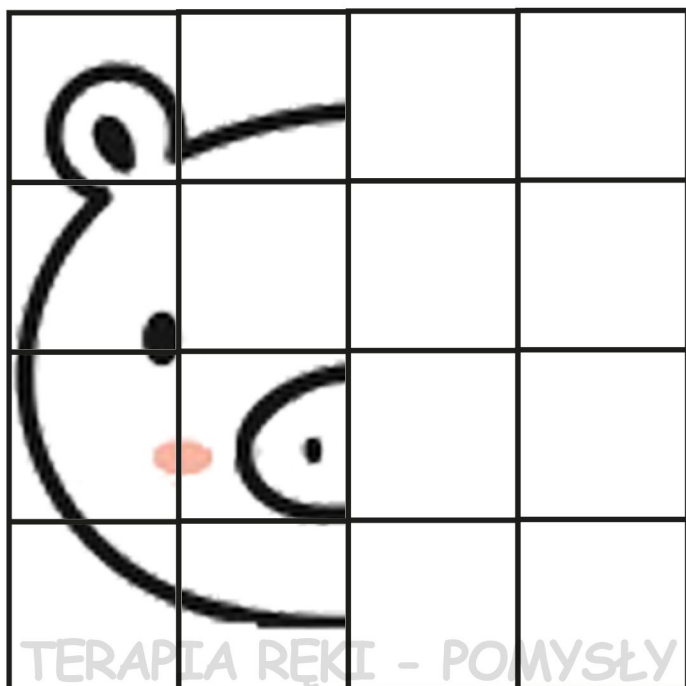

TERAPIA RĘKI - POMYSŁY
AGNIESZKA WOJCIECHOWSKA

KARTA PRACY - NUMER 7

POTRZEBNE MATERIAŁY:



NARYSUJ PO ŚLADZIE I POKOLORUJ WEDŁUG WZORU.

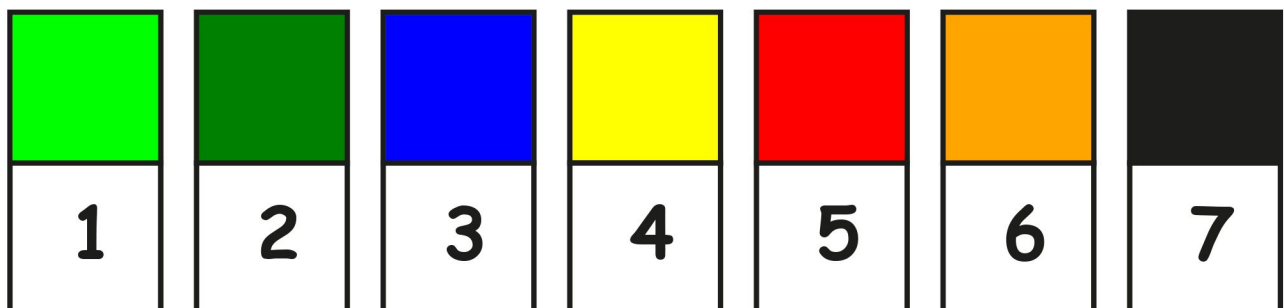
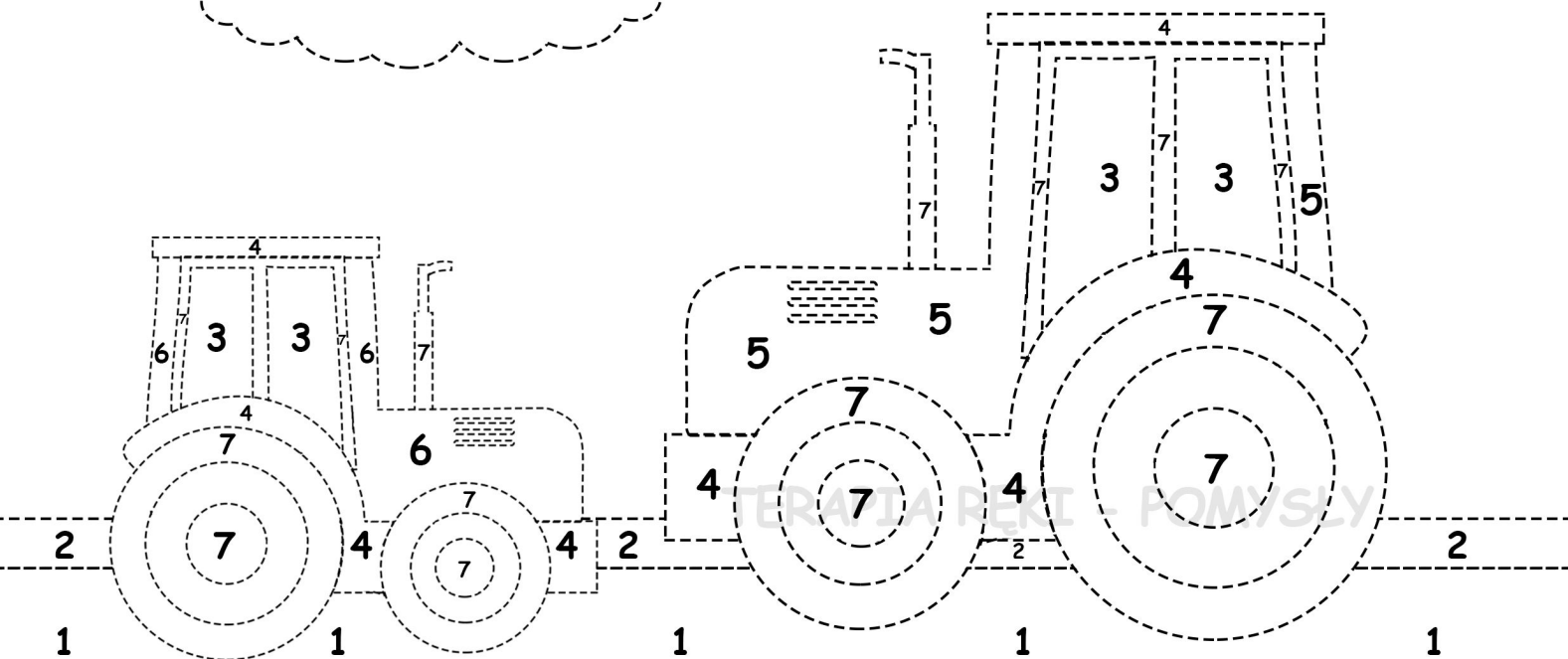
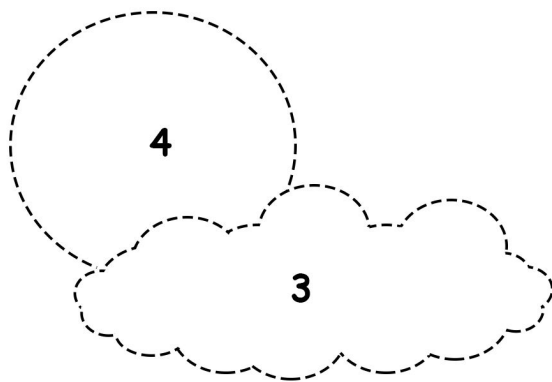

KARTA PRACY - NUMER 8

POTRZEBNE MATERIAŁY:



POKOLORUJ ODPOWIEDNIĄ ILOŚĆ KRATEK.











CZY JABŁKA
POTRAFIĄ
PŁYWAĆ?

TERAPIA RĘKI - POMYSŁY
AGNIESZKA WOJCIECHOWSKA



TAK, MAJĄ
W SOBIE
POWIETRZE.

ZRÓB EKSPERYMENT :)

KARTA PRACY - NUMER 9

POTRZEBNE MATERIAŁY:



JAKIE ZNASZ
RODZAJE
ZBÓŻ?



WSIĄDŹ W TRAKTOR I POJEDŹ DO MŁYNA.

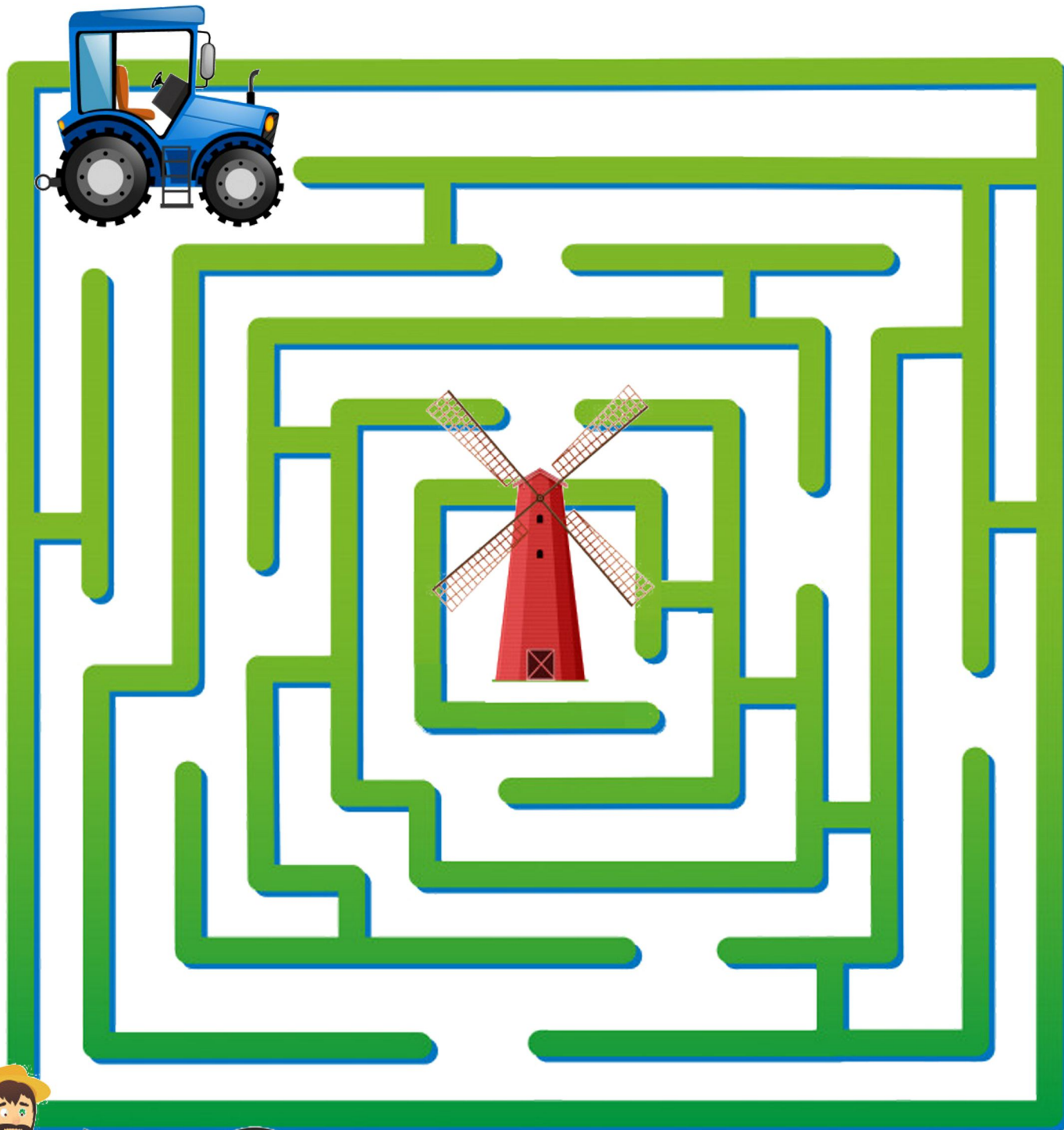

PSZENICA, ŻYTO,
JĘCZMIEN, OWIES.

TERAPIA RĘKI - POMYSŁY
AGNIESZKA WOJCIECHOWSKA

KARTA PRACY - NUMER 10

POTRZEBNE MATERIAŁY:



WYKLEJ OWCĘ WATA, DORYSUJ OBOK NIEJ
KOLOROWE KWIATY.



DZIECKO OWCY
TO JAGNIĄTKO.

TERAPIA RĘKI - POMYSŁY
AGNIESZKA WOJCIECHOWSKA

KARTA PRACY - NUMER 11

POTRZEBNE MATERIAŁY:

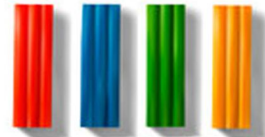

NARYSUJ ŚWINKĘ PO ŚLADZIE.
WYKLEJ KROPKI PLASTELINĄ.

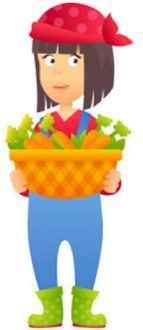

CZY ŚWINKI
PIJĄ DUŻO
WODY?

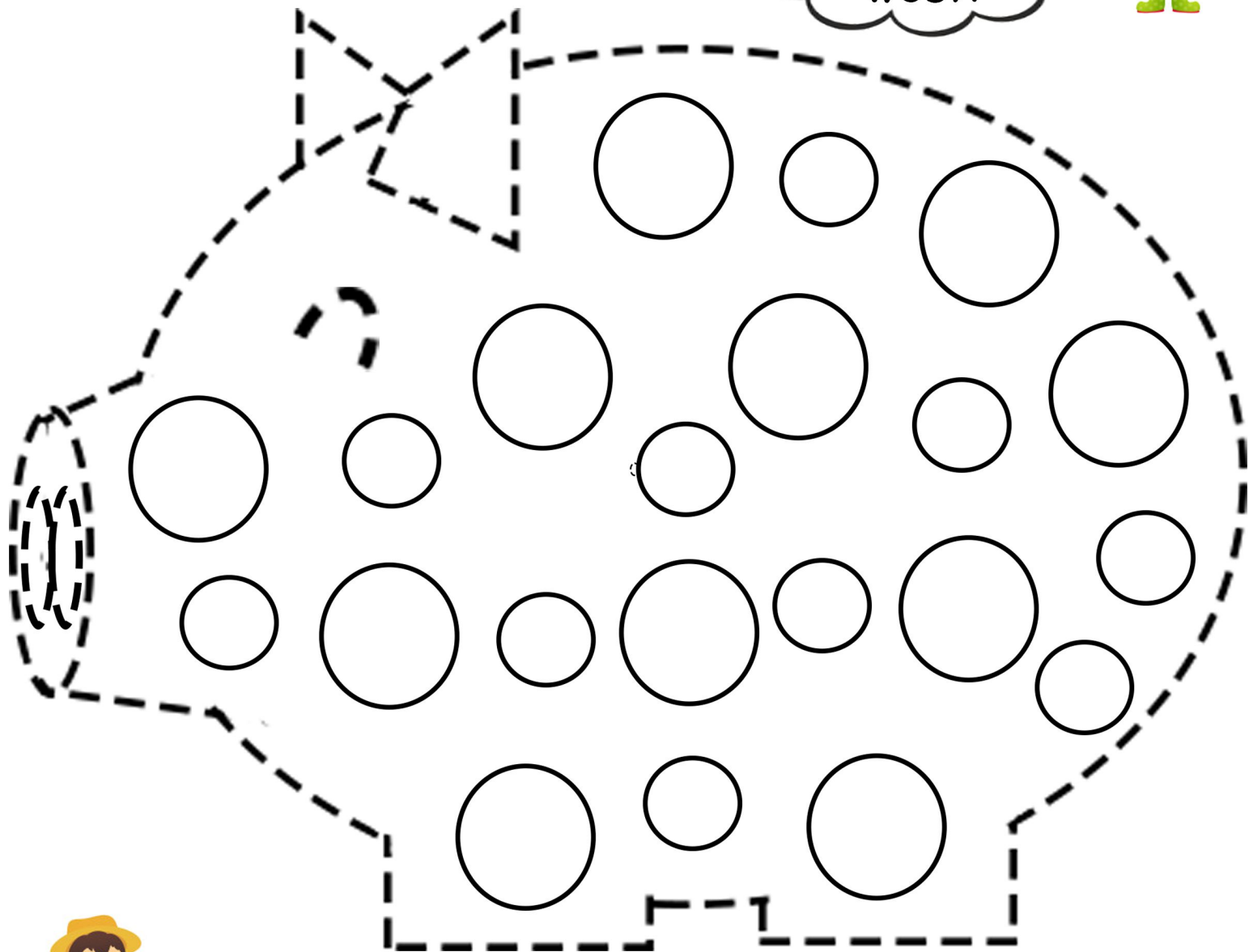

DZIENNIE PIJĄ
NAWET 7 BUTELEK
2 LITROWYCH
WODY.

TERAPIA RĘKI - POMYSŁY
AGNIESZKA WOJCIECHOWSKA

KARTA PRACY - NUMER 12

POTRZEBNE MATERIAŁY:



POLICZ I POKOLORUJ ODPOWIEDNIĄ ILOŚĆ KROPLI.

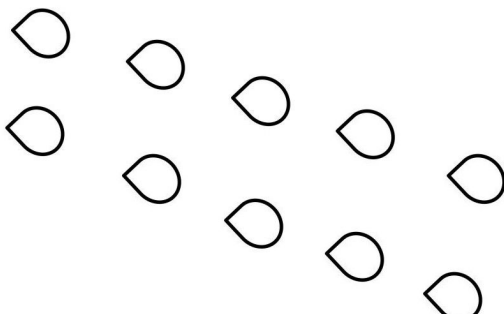

JAK ROŚLINY
ZAOPATRUJĄ SIĘ
W WODĘ?

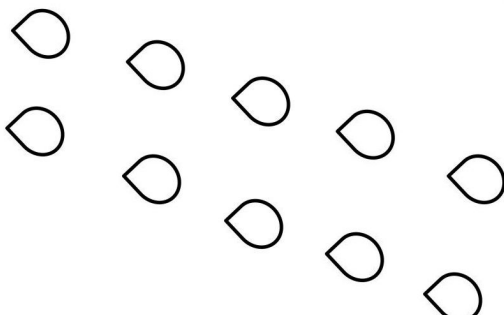
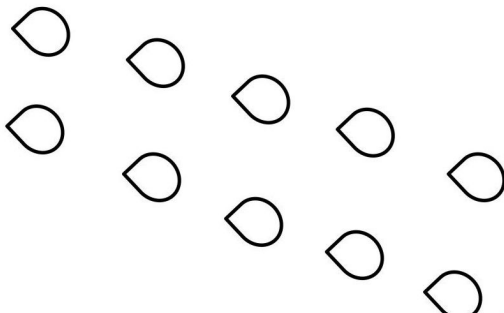

POBIERAJĄ
WODĘ KORZENIAMI
Z GLEBY.

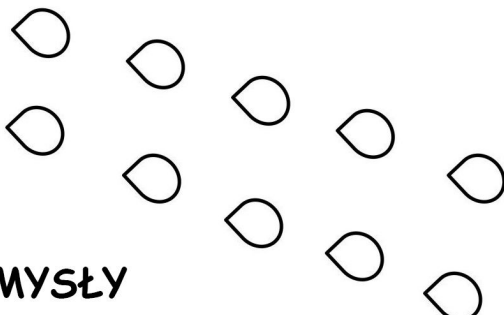

KARTA PRACY - NUMER 13

POTRZEBNE MATERIAŁY:



A CZY TY
KIEDYŚ JECHAŁEŚ
TRAKTOREM?



ZAPROWADŹ POJAZD DO CELU.



KARTA PRACY - NUMER 14

POSMARUJ TĘCZĘ KLEJEM, NASTĘPNIE WYSYP
NA NIĄ CUKIER. POMALUJ JĄ FARBAMI.

